

WIDE PORTFOLIO ...

MA01 floating connectors are produced with eight different pin counts from 30 to 140 pins and in nine mating heights for stacking connections from 8 to 30 mm. All products marked in the table are already available. Please, contact JAE for further information.

FLOATING SIDE	FIXED SIDE	Mating height (mm)	Number of pins								
			30	40	60	80	90	100	120	140	
MA01F□□□VAAB	MA01R□□□VABB	8	■	■	■	■	■	■	■	■	■
MA01F□□□VAAB	MA01R□□□VADB	10	■	■	■	■	■	■	■	■	■
MA01F□□□VABB	MA01R□□□VABB	14	■	■	■	■	■	■	■	■	■
MA01F□□□VABB	MA01R□□□VADB	16	■	■	■	■	■	■	■	■	■
MA01F□□□VAAB	MA01R□□□VANB	18	■	■	■	■	■	■	■	■	■
MA01F□□□VACB	MA01R□□□VABB	20	■	■	■	■	■	■	■	■	■
MA01F□□□VACB	MA01R□□□VADB	22	■	■	■	■	■	■	■	■	■
MA01F□□□VABB	MA01R□□□VANB	24	■	■	■	■	■	■	■	■	■
MA01F□□□VACB	MA01R□□□VANB	30	■	■	■	■	■	■	■	■	■
MA01F□□□VABB	MA01R□□□HAYB	Vertical (L)	■	■	■	■	■	■	■	■	■
MA01F□□□VACB	MA01R□□□HAYB	Vertical (H)	■	■	■	■	■	■	■	■	■

■ Available. Please, contact JAE for further information.

... GREAT VARIABILITY

In addition, there are two versions for vertical connection – high or low. You are welcome to contact us if you have special requirements.

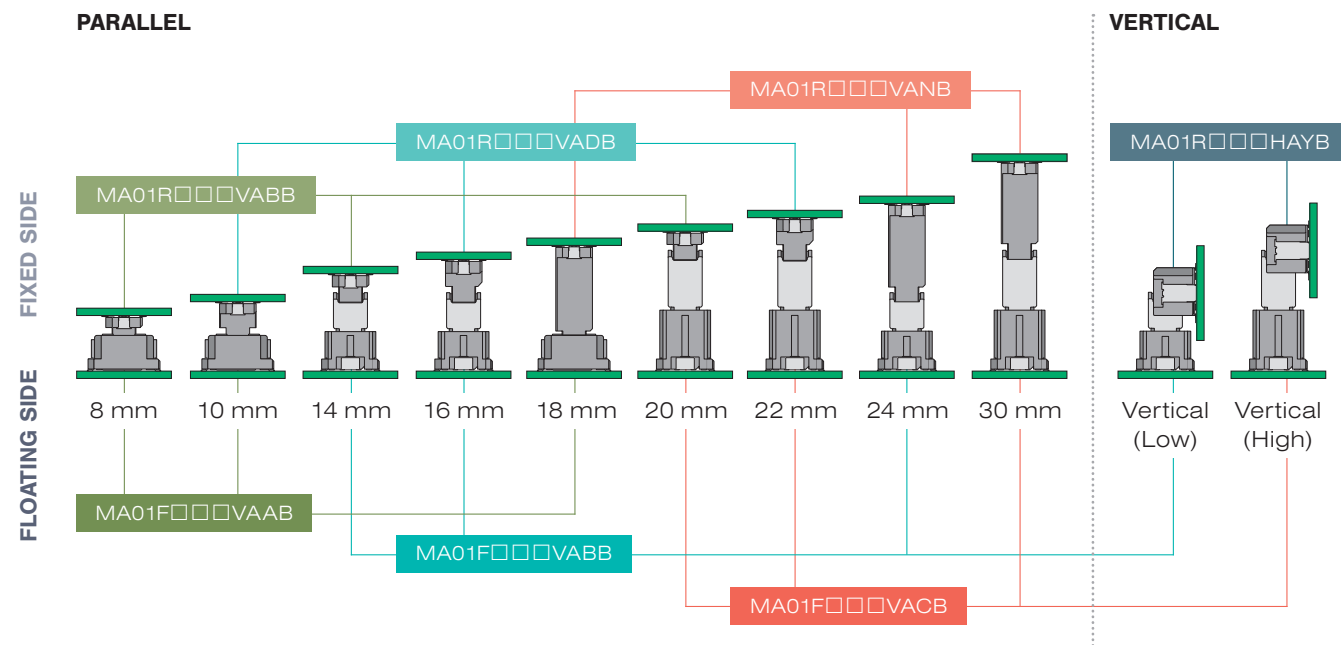

Tolerance in stacking height between PCBs: ±0.5 mm in Z axis

WE CONNECT

MARKET-LEADING TECHNOLOGY & UNCOMPROMISING CUSTOMER ORIENTATION

MA01 floating connectors are designed to meet the high and various needs of modern industrial and automotive applications. JAE connects requirements and solutions.

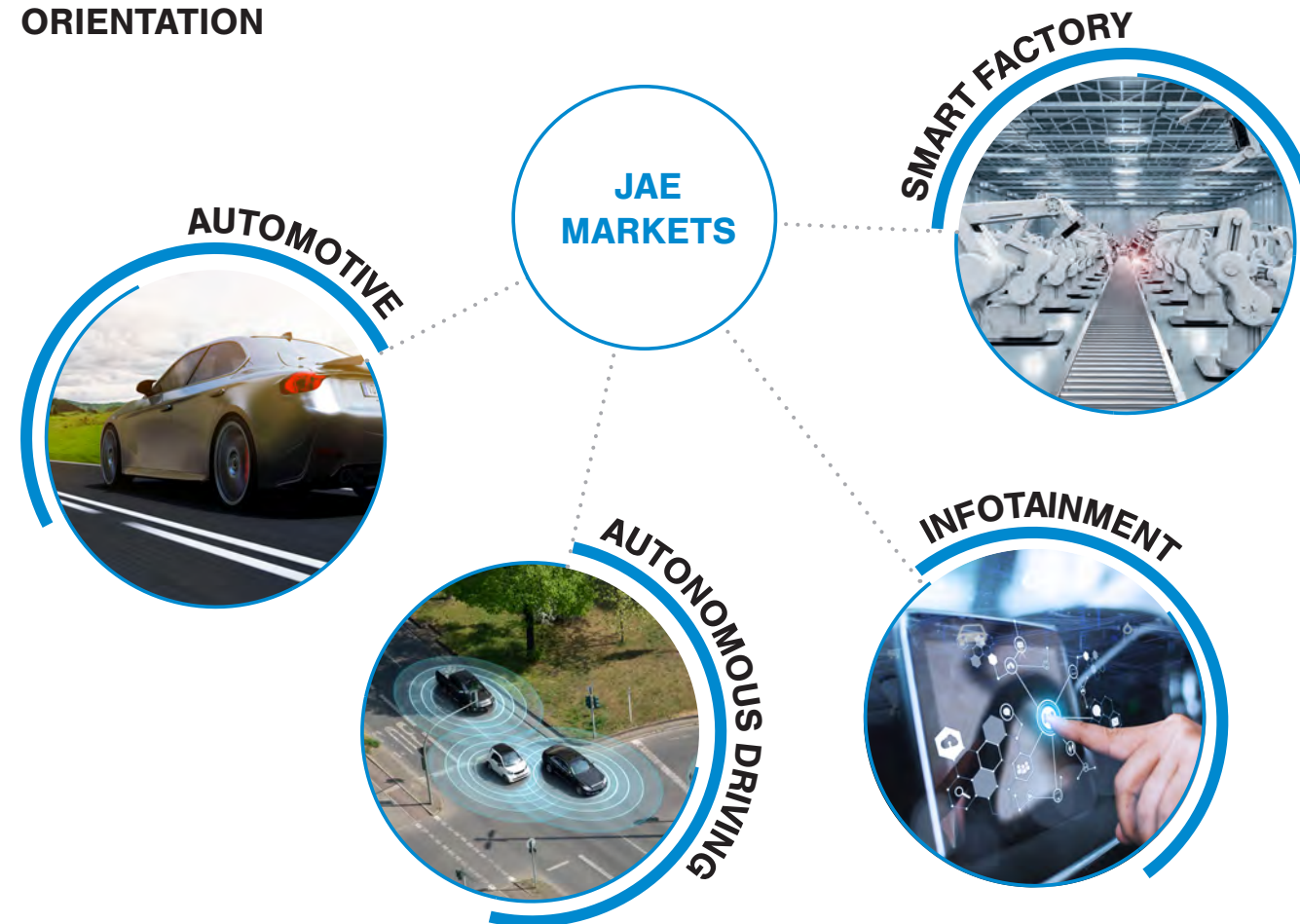

Connect with JAE – and profit from innovative manufacturing processes, outstanding production capacities, high-speed transmission and unsurpassed reliability.

Head Office
Japan Aviation Electronics Industry, Ltd.
21-1, Dogenzaka 1-chome, Shibuya-ku, Tokyo 150-0043, Japan
Tel: +81-3-3780-2711, Fax: +81-3-3780-2733
www.jae.com

Europe
JAE Europe, Ltd.
Royal Pavilion, Tower 3, First Floor, Wellesley Road, Aldershot, Hampshire, GU11 1PZ, UK
Tel: +44-1252-551100, Fax: +44-1252-551100

North America
JAE Electronics, Inc.
142 Technology Drive, Suite 100, Irvine, CA 92618-2430, U.S.A.
Tel: +1-949-753-2600, Fax: +1-949-753-4706



WE CONNECT

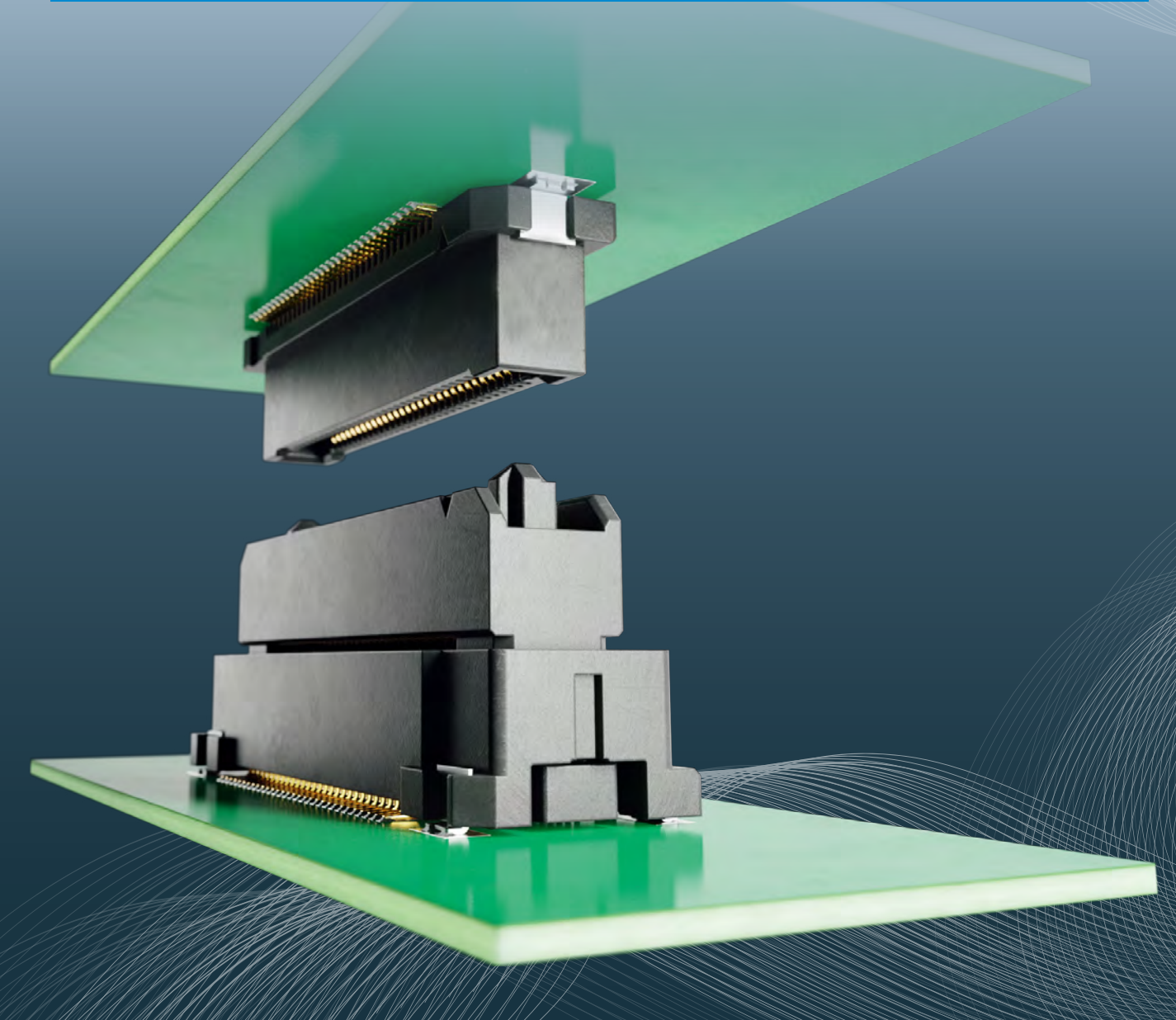

THE NEW MA01 SERIES BtB HIGH SPEED TRANSMISSION FLOATING CONNECTORS FOR AUTOMOTIVE

- Perfect alignment
- High speed data transmission
- High contact reliability
- Multiple mounting options
- Tailored to automotive market requirements (-40 °C to +125 °C)



May 2021 Subject to change without notice. Errors and omission excepted.

THE BEST WAY TO STAY IN CONTACT: THE NEW MA01 FLOATING TYPE CONNECTORS

The use of connectors in electronic devices that are subject to motion, and especially in the automotive industry, is challenged by two major issues: the compensation of manufacturing and assembly tolerances and the allowance for board movements due to shocks, vibrations and temperature changes.

The new MA01 series offers a robust double contact point. In addition, the reliable flat contact surface prevents the challenges related to micro-vibration.

As one of the world's leading developers and suppliers of innovative connectors, JAE meets the growing demand for high-quality and high-performance floating board-to-board connectors for highly efficient and cost-effective automated PCB assembly.

EASY APPLICATION. HIGH RELIABILITY. STRONG PERFORMANCE.

To offer our customers maximum application and design flexibility, JAE's new MA01 series covers a wide, market-leading range of floating board-to-board connectors with mating heights from 8 to 30 mm and a pin count from 30 to 140 pins for parallel or vertical orientation of the PCB.

Both the floating and the fixed connector side are mounted with a protective cap in order to prevent the ingress of foreign substances and facilitate automatic assembly. A pin height of 0.60 mm ensures good visibility of the solder connection, and mis-mating is prevented by a special guide construction.



MA01 CONNECTORS AT A GLANCE: GREAT FEATURES AND STRONG BENEFITS

JAE's cutting-edge MA01 BtB floating connectors combine perfect alignment, compact design, high data rate and wide temperature range with high reliability, excellent durability and great variability.

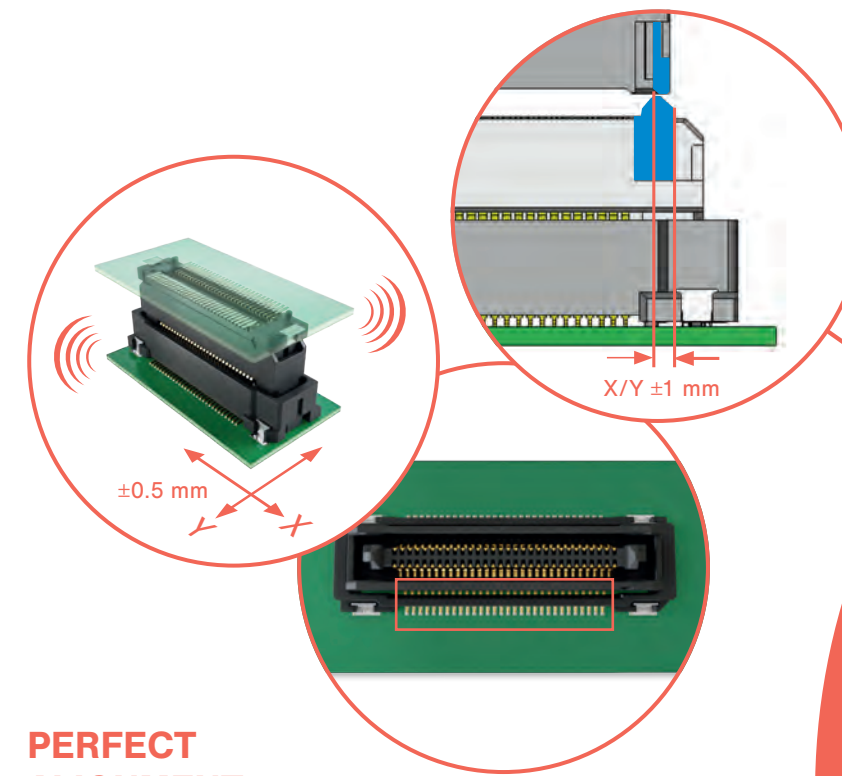

PERFECT ALIGNMENT

- Effective floating range: X/Y ± 0.5 mm movable
- Special mating guide construction (X/Y ± 1 mm) prevents misalignment at PCB assembly
- Easy fitting during manual assembly due to special guiding form
- Excellent optical controllability and a production friendly structure: JAE connectors have visible SMT contacts

HIGH SPEED DATA TRANSMISSION

- High data rate transmission: 8 Gbps+
- Equivalent to 10GBASE-KR, PCIe Gen3

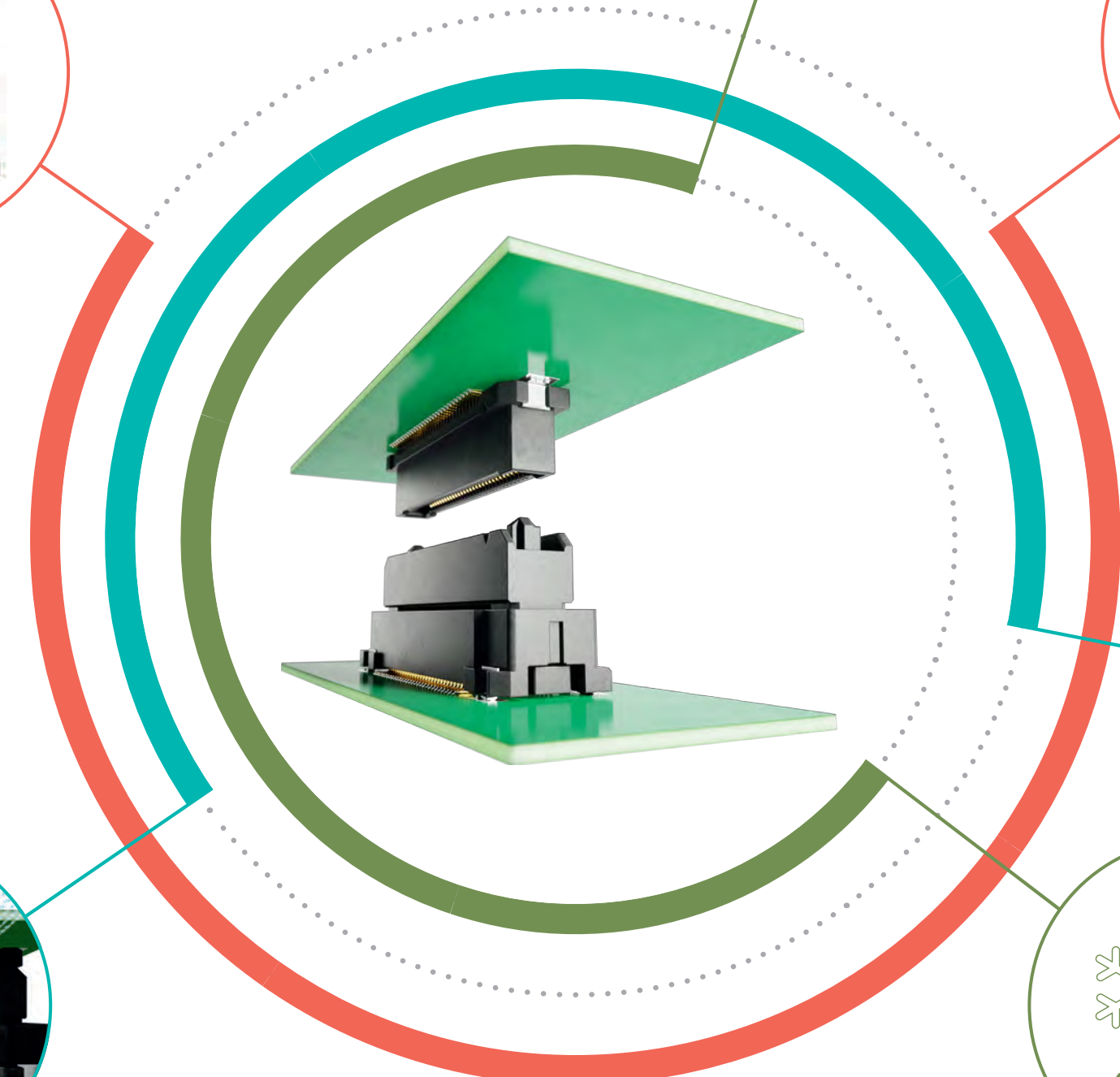
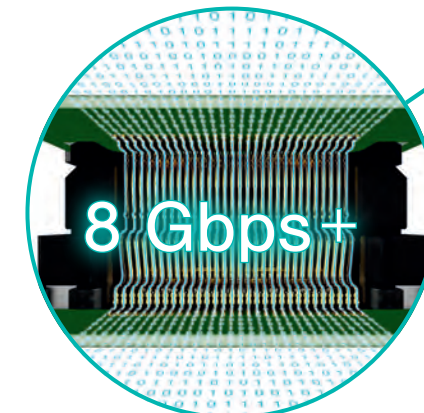

HIGH CONTACT RELIABILITY

- Double contact structure
- Rolled surface connection (lower insertion force, higher wear resistance)

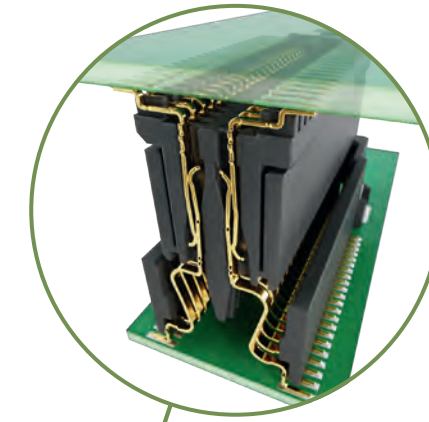

SMALL, COMPACT DESIGN

- Various pin counts (30-140 pins)
- High pin density (0.635 mm pitch)
- Easy to assemble due to alignment pegs
- A special cap protects the connector's mating area prior to usage and facilitates pick and place automatic assembly

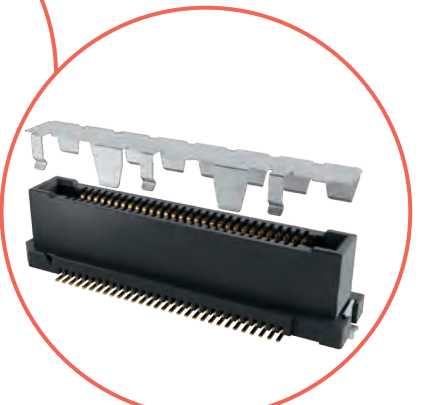
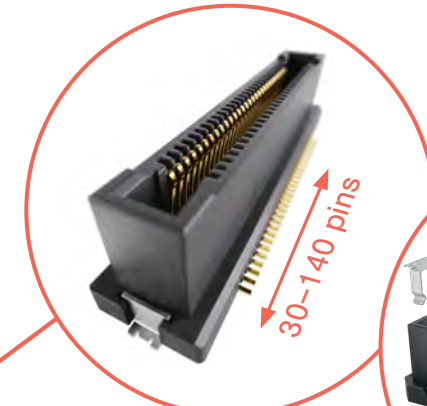

MULTIPLE MOUNTING OPTIONS

- Different stacking heights (8 to 30 mm)
- Multiple BtB PCB mating connections (parallel and vertical, in low and high versions)

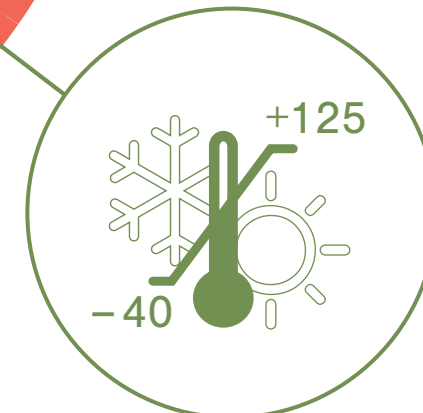
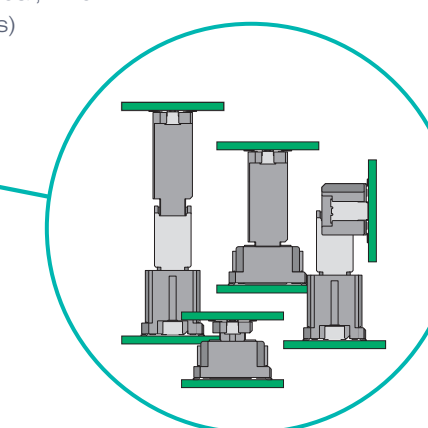

WIDE OPERATION TEMPERATURE RANGE

- -40 °C to $+125$ °C
- Tailored to automotive market requirements