

molex

SLIMSTACK FLOATING BOARD-TO-BOARD CONNECTORS

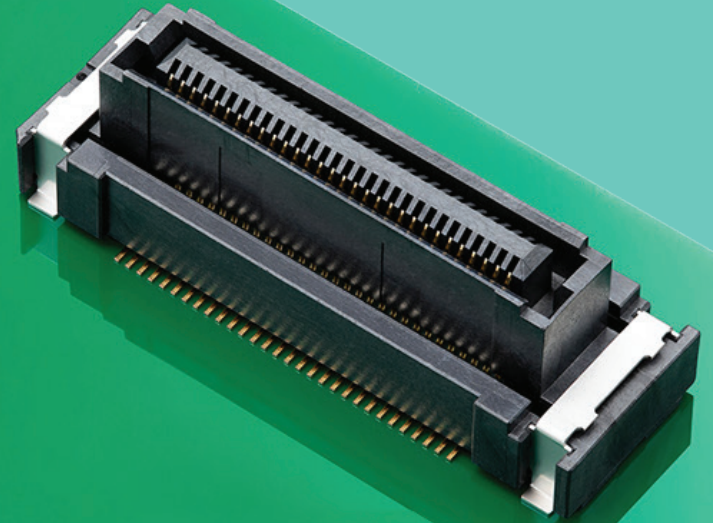
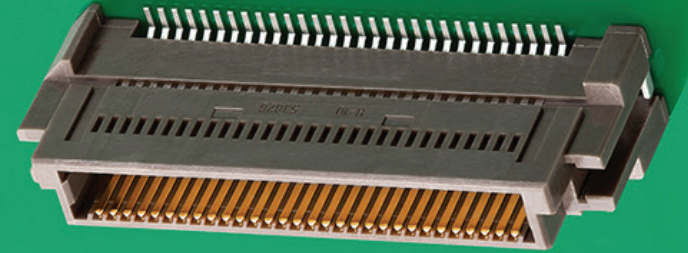

OVERVIEW OF SLIMSTACK FLOATING BOARD-TO-BOARD CONNECTORS

Introducing SlimStack Board-to-Board FSB and 0.635mm-pitch Floating Connectors, which feature a large floating range to facilitate assembly. These connectors are ideal for a wide range of applications in the automotive, industrial and consumer markets.

Featuring
a large floating
range to facilitate
assembly

FSB Floating Series

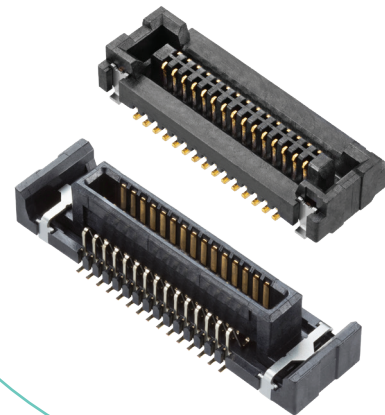

0.635mm-pitch Floating Series

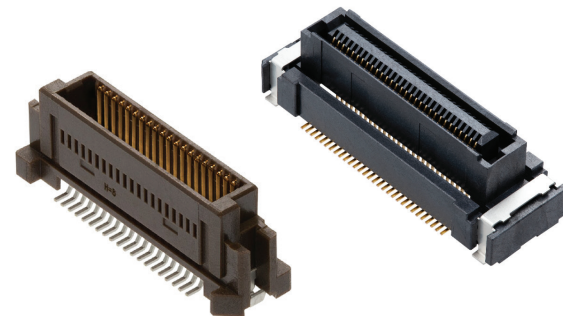

FLOATING RANGE

Advantages of the floating function:

- Keeps solder from cracking by absorbing shock from misalignment during PCB repair
- Enables a secure connection of multiple board-to-board connectors on one PCB

**SlimStack
0.635mm-Pitch
Floating Connectors
have a $\pm 0.70\text{mm}$
floating range in the
X and Y axes.**

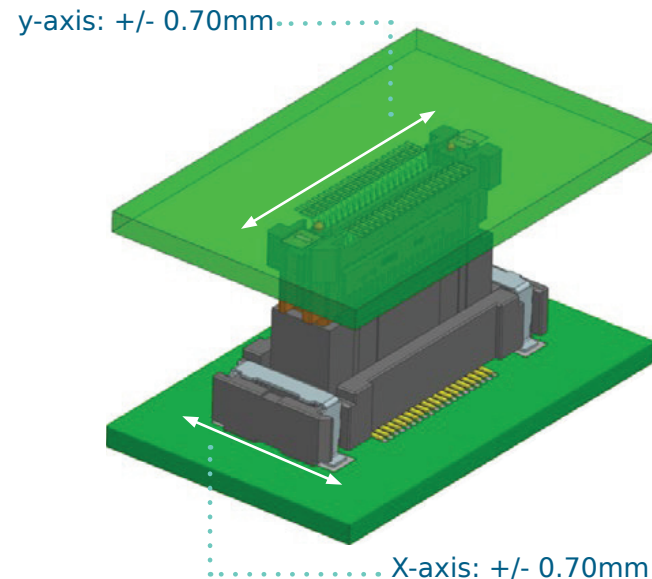

IMPROVED ASSEMBLY

- Easy assembly with secure mating
- Reduced impact of shock and vibration
- Better reliability under challenging environmental conditions

The floating range facilitates proper connections in the event of misalignment or blind mating.

**Better
reliability under
challenging
environmental
conditions**

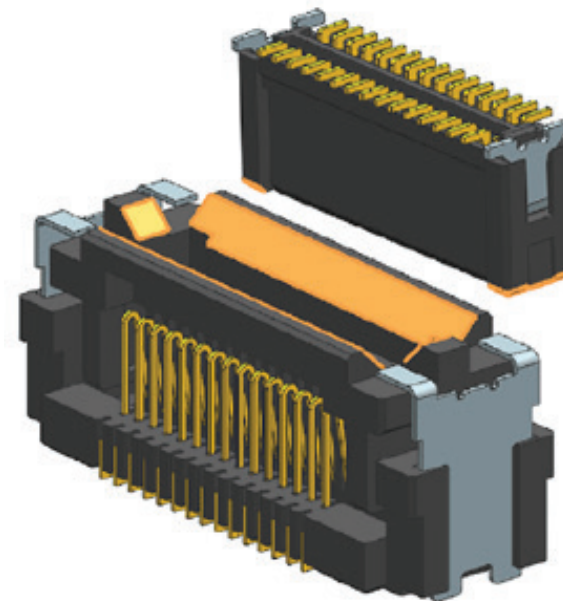

COST EFFECTIVE

A generous floating range facilitates blind mating and board-to-board connections, eliminating the need for high-cost flexible printed circuits to connect PCBs.

As a result, the SlimStack Floating Board-to-Board Connectors deliver both design flexibility and lower component costs.

**SlimStack Floating
Board-to-Board
Connectors
deliver both
design flexibility
and lower
component costs**

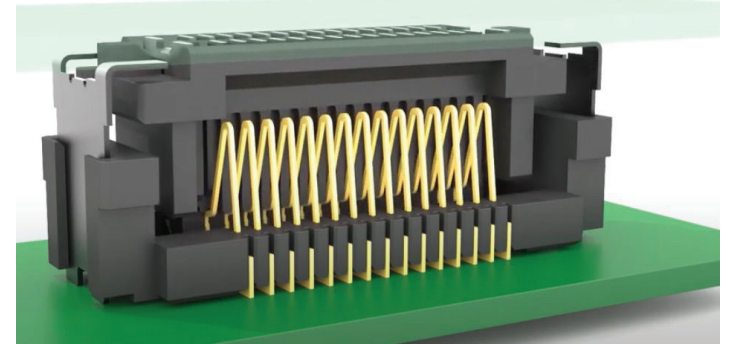

SPACE SAVINGS

Modern advanced intelligence applications (e.g. ADAS, industrial automation) continue to shrink in size, therefore creating the need for a more compact connector. The SlimStack FSB series is one of the smallest in the board-to-board floating connector market.

The SlimStack FSB series is one of the smallest in the board-to-board floating connector market

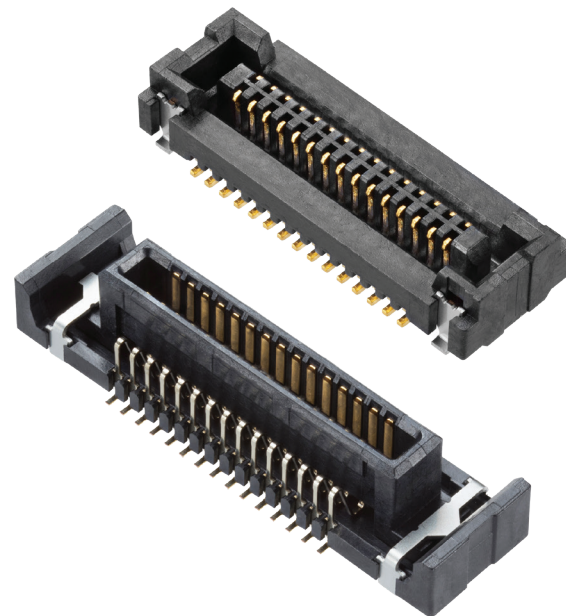

HIGH OPERATING TEMPERATURES

Increasing product densities and performance needs demand high operating temperatures. Having the ability to withstand higher operating temperatures allow SlimStack Floating series to be used in high-performance products.

Molex's SlimStack Board-to-Board FSB and 0.635-Pitch Floating Connectors can operate at up to 125°C.

**FSB Series and
0.635mm-Pitch
Floating Series
can operate at
up to 125°C**

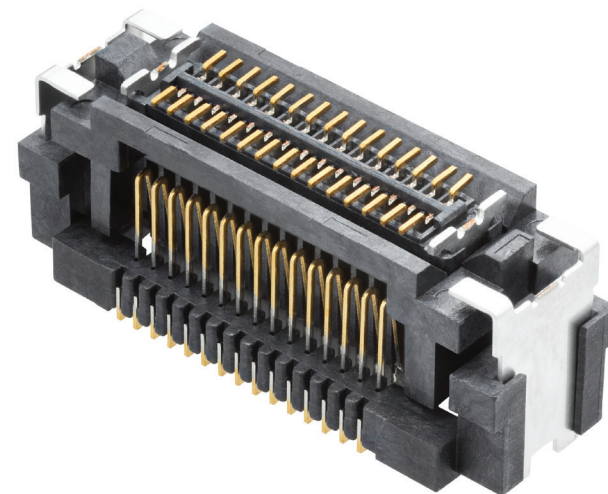

MARKETS AND APPLICATIONS



Automotive



In-Vehicle Infotainment



ADAS Applications



Consumer



Gaming



Security Camera



Datacom



Server Storage



Base Station



Industrial



Automation Machine



Vision Sensor

SLIMSTACK 0.635MM-PITCH FLOATING CONNECTORS

Series

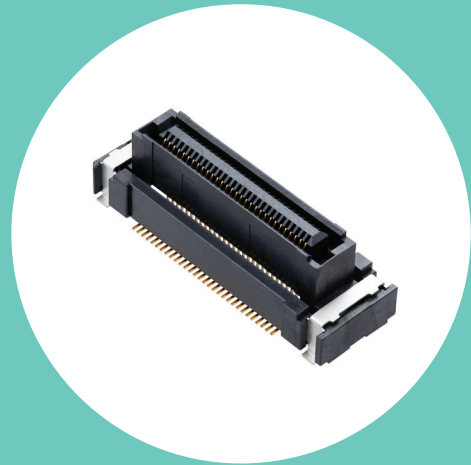

Floating type Receptacle
[209168](#) Series

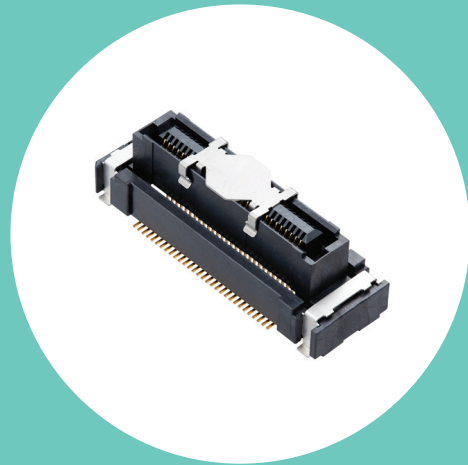

With cap
(packaging style)



SLIMSTACK 0.635MM-PITCH FLOATING CONNECTORS

Features and Benefits

Key Features

- 1 Wide Floating Range
- 2 High Operating Temperatures
- 3 Variable Stack Heights

Benefits

- 1 Easy Assembly
The wide floating range makes automatic assembly or blind mating easier and supports mass production.
- 2 Design Flexibility
Variable stack heights within the same PCB layout on the plug side and high operating temperatures offers much-needed design flexibility.

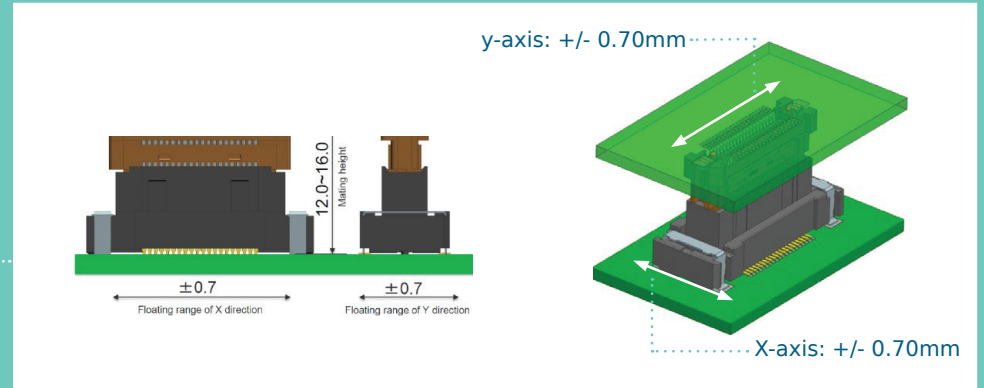

Rigid type
Receptacle
H6-10 [52885](#)

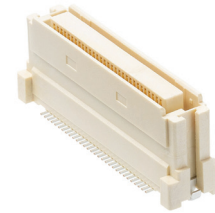

Rigid type
Receptacle
H12-16 [52901](#)

SLIMSTACK 0.635MM-PITCH FLOATING CONNECTORS

Specifications

Pitch	0.635mm	Voltage (max.)	100V
Height	12.00 to 16.00mm	Current Per Pin (max.)	0.5A
Width	10.10mm	Data Rate* ¹	6.2 Gbps
Length* ²	TP + 2.85mm	Floating Range	±0.70mm
Circuit Size	40, 60, 80	Plating	Gold
Durability	50 Cycles	Operating Temperature	-40 to +125°C

*¹ Please refer to Guide for Hardware Interface Standard on Molex.com

*² TP = (circuit/2-1) x pitch

Circuit Availability

Circuit	H12	H13	H14	H15	H16
40	●	●	●	●	●
60	●	●	●	●	●
80	●	●	●	●	●

SLIMSTACK FSB SERIES

Series

FSB3

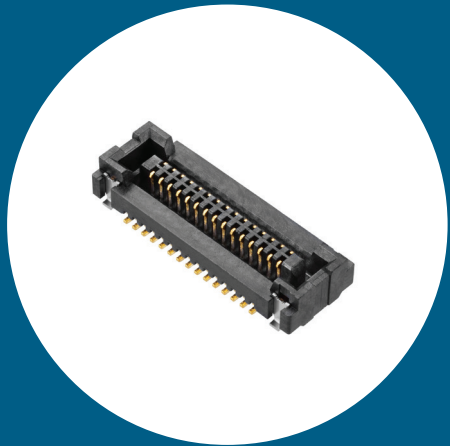

Receptacle
[204927](#)
Series

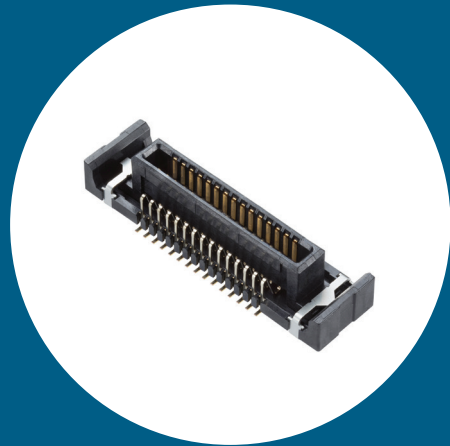

Plug
[204928](#)
Series

FSB5

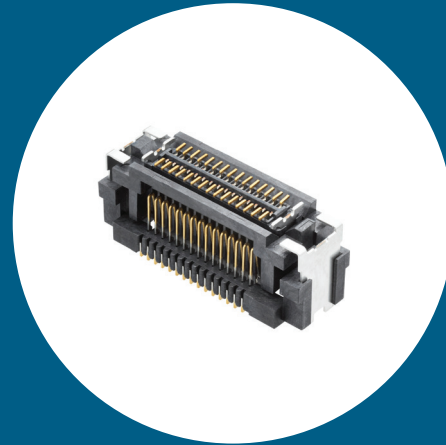

Receptacle
[203955](#)
Series

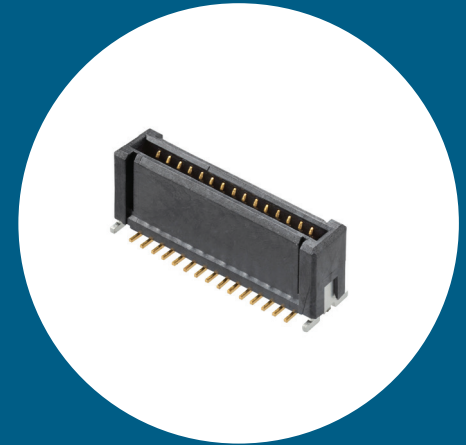

Plug
[203956](#)
Series

SLIMSTACK FSB SERIES

Features and Benefits

Key Features

- 1 Floating Structure
- 2 Space Saving
- 3 Variable Stack Heights

Benefits

- 1 One of the Smallest, Best-in-Class Floating Connectors
The FSB5 connector has a 5.00mm mating height and a 3.80mm width. The FSB3 series has a 3.00mm mating height and a 3.20mm width. These are some of the smallest floating connectors in the industry, mitigating space constraints.
- 2 Large Floating Range
Large floating ranges ($\pm 0.30\text{mm}$ for FSB3 and $\pm 0.50\text{mm}$ for FSB5) make automated assembly and blind mating easier while supporting mass production.

One of the smallest in the B-to-B floating connectors market provides space savings

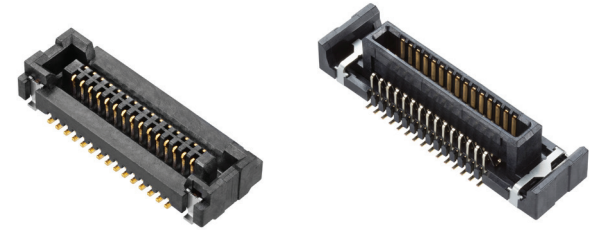

Soft floating force makes assembly and operations easy

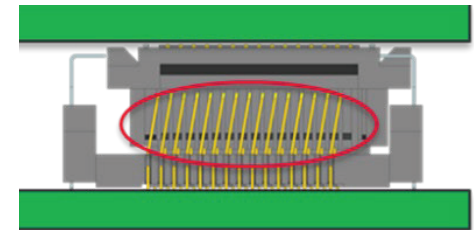

SLIMSTACK FSB SERIES

Specifications

Pitch	0.40mm
Height	3.00/5.00mm
Width	3.20/3.80mm
Length ^{*2}	TP + 5.40mm
Circuit Size	20 to 60
Durability	30 Cycles

Voltage (max.)	40V
Current Per Pin (max.)	0.3A
Data Rate ^{*1}	6 Gbps
Floating Range	±0.30/0.50mm
Plating	Gold
Operating Temperature	-40 to +125°C

Circuit Availability

Circuit	FSB3	FSB5
20	●	●
30	●	●
40	●	●
50	●	●
60	●	●

*1 Please refer to Guide for Hardware Interface Standard on Molex.com

*2 TP = (circuit/2-1) x pitch

molex