

PUSHBUTTON SWITCHES

Series - H2200 Double Pole

Momentary Snap Action Pushbutton Switches

FEATURES

- Double pole
- Optional mounting adapters
- Various styles and colors of pushbuttons
- Solder terminals
- Momentary snap action
- Protective shields can be ordered separately to prevent accidental actuation on "W" case model
- Black pushbutton supplied as standard
- Other colors available

SPECIFICATIONS

- Operating force: 5.5 ± 1.5 lbs (24.2N \pm 6.6N)
- Release force: 1 lb. minimum (.45g)
- Electrical life: 25,000 operations minimum at rated load
- Terminals: Solder
- Weight approx.: .05 lb. (.023g)



CURRENT RATINGS

Catalog Number	Number of Poles	Type of Operation	28VDC Inductive	120VAC Inductive ^①
H2211	2	Momentary	10	10
H2222	2	Momentary	10	10
H2266	2	Momentary	10	10

^① p.f.=.75

SELECTION TABLE

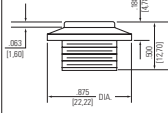
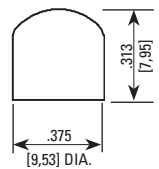
SERIES AND TYPE

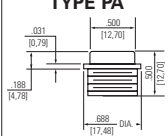
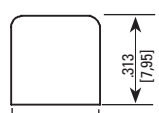
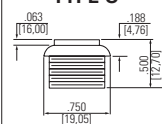
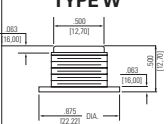
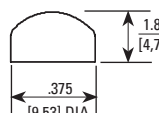
	Part Number	Circuit	Adapter Type ^① and Color ^③			Pushbutton Type and Color			
			Type	Color	Code Suffix	Type ^②	Color	Code Suffix	
 H2211PB3 With "P" Adapter	H2211	2 P.S.T.-NO Double Break	TYPE P 	Black Clear	PB P	NO. 2 	Red Black	2R 2	
	H2222	2 P.S.T.-NC Double Break							
 H2266 Without Mounting Adapter	H2266	2 P.D.T. Double Break	TYPE PA 	Black Clear	PAB PA	NO. 3 	Red Black	3R 3	
			TYPE U 	Black Clear	UB U				
			TYPE W 	Black Clear	WB W	NO. 4 	Red Black	4R 4	

^① Clear anodized aluminum is standard. All threads are 1/2"-32 NS-2B internal; 5/8"-24 NEF-2A external except as noted.

^② The different pushbutton types are only available when using with one of the 4 different adapters.

^③ When used with any of these adapters the switch can be used as part of the UPA group of switches on pages B16 and B17.

WHEN ORDERING SPECIFY...

- **For switch with pushbutton only** - specify catalog number of base switch followed by code for pushbutton color. Use code R for red and leave blank if black button is desired. Examples:

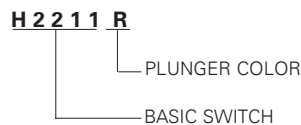

- **For switch with mounting adapter** - specify catalog number of base switch followed by suffix letters and numbers for type and color of adapter and pushbutton. Example:

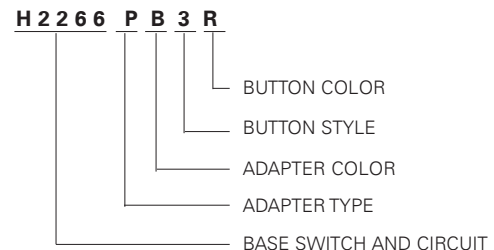

Series - H2200 Double Pole

PUSHBUTTON SWITCHES Momentary Snap Action Pushbutton Switches

APPROXIMATE DIMENSIONS - H2200

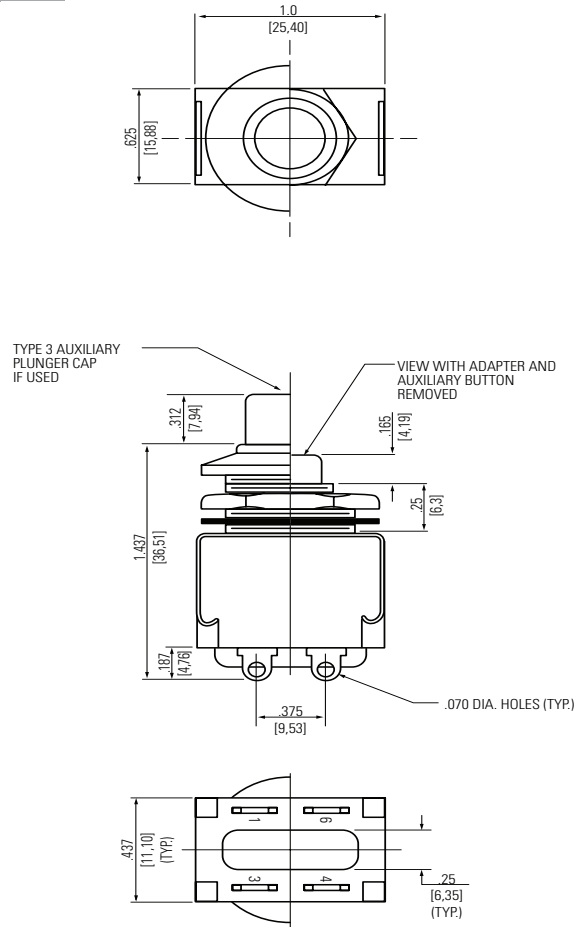

BASIC SWITCH AND SCHEMATIC DIAGRAM

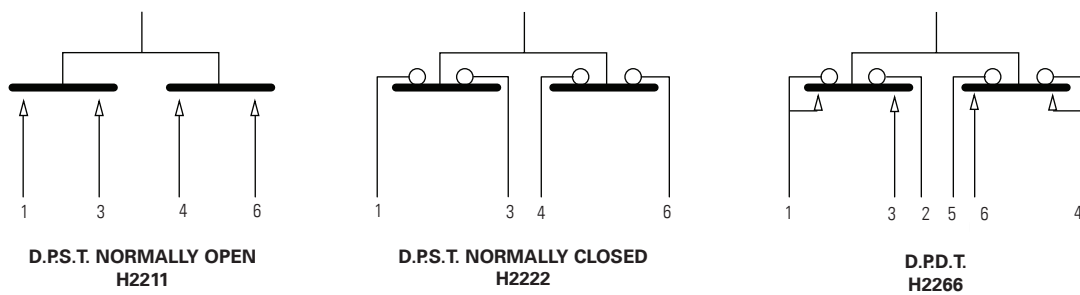

STANDARD
0.00 = inches
[0,0] = mm

Dimensions for reference only.