

PUSHBUTTON SWITCHES

Series - J300

Alternate Action Moisture Proof Pushbutton Switches

FEATURES

- Alternate action push-push
- Moisture proof
- Snap action contact design
- Seven adapter styles
- Four button colors
- EMI/RFI version (J334)

SPECIFICATIONS

- DPDT (J333, J334) and two circuit (J313)
- EMI/RFI shielded (J334P6)
- Seal level 2 per MIL-PRF-8805
- Operating force: 2.75 ± 1 lb (12 IN. \pm 4.4N)
- Electrical life: 25,000 operations minimum
- Operating temperature: -40°F to +185°F (-40°C to +85°C)
- Total plunger travel: 0.200 in. (5.1mm) approx.
- Weight (approx.): 0.035 lbs (15.9g)
- Available in number 6 button style only

CURRENT RATINGS

Part Number	Number of Poles	Type of Operation	28VDC			120VAC		
			Resistive Load	Inductive Load	Lamp Load	Resistive Load	Inductive Load ^①	Lamp Load
J313	1	Alternate	10	5	1	10	5	1
J333	2	Alternate	1	—	1	1	—	1
J334 ^②	2	Alternate	1	—	—	1	—	—

^① p.f.=.75

^② EMI/RFI shielded

ORDERING INFORMATION

J 3 1 3 W 6

- BUTTON STYLE
- CLEAR "W" ADAPTER
- 2 CIR. SWITCH TYPE

J 3 3 4 P 6 R

- RED BUTTON
- DPDT EMI/RFI SHIELDED SWITCH

J 3 3 3 P B 6 R

- RED BUTTON
- BUTTON STYLE
- BLACK "P" ADAPTER
- DPDT SWITCH TYPE

SPECIFY ADAPTER

- Seven Adapter Styles
- Specify Black: B, Clear: No letter
- Plunger Color, Specify:
 - Black: No letter
 - Red: R
 - White: W
 - Gray: GY
- DPDT J333 and Two Circuit J313
- J334 only available as J334P6 or J334P6R

ADAPTER STYLES

TYPE HA

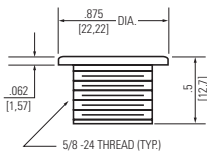

TYPE M

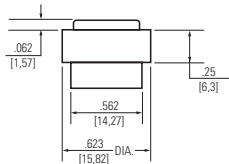

TYPE N

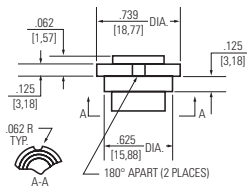

TYPE P

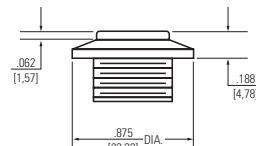

TYPE PA

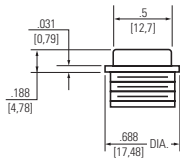

TYPE W

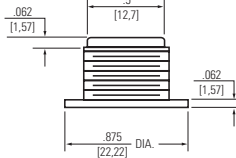

TYPE Y

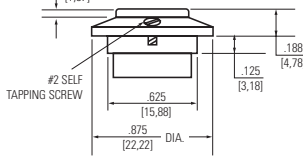

STANDARD
0.00 = inches
[0,0] = mm

Dimensions for reference only.

Series - J300

PUSHBUTTON SWITCHES Alternate Action Moisture Proof Pushbutton Switches

DIMENSIONS - J300

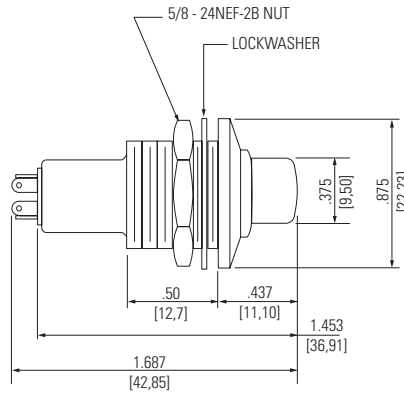

SCHEMATIC DIAGRAMS

J313 TYPE

J333 AND J334 TYPE

TWO CIRCUIT



J300

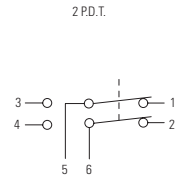
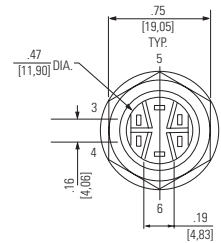
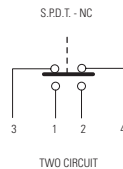
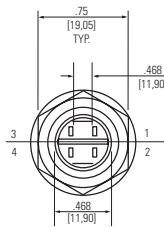

"W" J334P6 - EMI/RFI SHIELDING

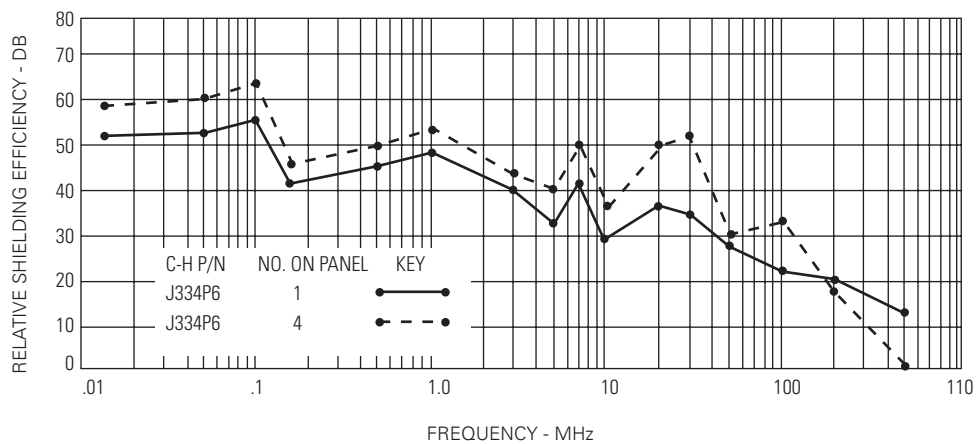

Graphic illustration defines relative shielding efficiency of RFI shielded component/ components over unshielded device.

STANDARD
0.00 = inches
[0,0] = mm

Mounting dimensions for reference only.