



Standard (Bushing Mounting)



High/Random Vibration (Flush Mounting)

**Single-Pole High Performance**

**Qualified**

To MS25244, MS25244-P and MS25244-PT of MIL-C-5809 (MS25244PT is a substitute for MS25017) .

**Lightweight**

Circuit breaker weighs only 43 grams.

**High Interrupting Capacity**

Interrupts a 6,000A circuit at 30V, DC; 3,500A circuit at 120V, 400 Hz. AC.

**Performance Rated Circuit Breaker**

Exceeds military specification requirements for durability, vibration, mechanical shock, and acceleration. The 700 is a miniature push-pull breaker offering fast trip and high interrupting capacity. Its trip-free design prevents the breaker from being held closed manually on overloads.

A feature of the breaker is separate overload and mechanical latches. Separated in this way, the mechanical latch assures maximum endurance for the thousands of cycles of manual on-off operation, while the thermal latch combines both precise operation and durability.

**Bushing and Flush Mounting Options**

**PERFORMANCE DATA**

<b>Interrupting Capacity</b>	6,000A at 30V, DC; 3,500A at 120V, 400 Hz., AC
<b>Endurance</b>	At 120V, 400 Hz., AC or 30V, DC: inductive load — 2,500 cycles; resistive load — 5,000 cycles; mechanical cycling, no load — 5,000 cycles
<b>Overload Cycling</b>	100 operations at 200% rated current and rated voltage
<b>Dielectric Strength</b>	At sea level, 25°C 1,500V, AC. At 65,000 ft., 70°C 500V, AC. 1,500V, minimum
<b>Insulation Resistance</b>	Not less than 100 megohms at 500V, DC
<b>Voltage Drop</b>	Varies with rating (see "Ordering Information")
<b>Vibration</b>	Exceeds MIL-STD-202, Method 204, Condition A (Random Optional)
<b>Shock</b>	Exceeds 30G's, 11 Millisec (half-sine pulse) MIL-STD-202, Method 213 Test J
<b>Acceleration</b>	Exceeds 10G's
<b>Weight</b>	700-001: 43 grams (.1 lbs.). 700-089: 48 grams (.11 lbs.)
<b>Altitude Maximum</b>	65,000 ft.

**OVERLOAD CALIBRATION DATA**

Specification Table	@ 25°C		@ +71°C				@ -40°C				Test Time Parameters
	MIN	MAX	0.5 – 7 1/2A		10 – 50A		0.5 – 7 1/2A		10 – 50A		
			MIN	MAX	MIN	MAX	MIN	MAX	MIN	MAX	
Must Hold	115	—	60	—	70	—	156	—	148	—	% For 1 Hour
Must Trip	—	138	—	108	—	114	—	178	—	178	% Within 1 Hour
200% Overload	15	55.0	—	—	—	—	—	—	—	—	Seconds
400% Overload	2	7.0	—	—	—	—	—	—	—	—	Seconds
600% Overload	1	3.5	—	—	—	—	—	—	—	—	Seconds

Trip curve available.

**ORDERING INFORMATION**

		ADAPTER FLUSH MOUNTING PLATE						
		STANDARD		BASE & TERMINAL CONFIGURATION STYLE "P"		ALTERNATE BASE & TERMINAL CONFIGURATION STYLE "PT"		
MS APPROVAL STATUS	AMPERE RATING	VOLTAGE DROP MAX. *	MS P/N	SAFRAN MP P/N	MS P/N	SAFRAN MP P/N	MS P/N	SAFRAN MP P/N
MS Approved	5	0.25	MS25244-5	700-001-5	MS25244-P5	700-089-5	MS25244-PT5	700-092-5
MS Approved	7 1/2	0.25	MS25244-7 1/2	700-001-705	MS25244-P7 1/2	700-089-705	MS25244-PT7 1/2	700-092-705
MS Approved	10	0.25	MS25244-10	700-001-10	MS25244-P10	700-089-10	MS25244-PT10	700-092-10
MS Approved	15	0.25	MS25244-15	700-001-15	MS25244-P15	700-089-15	MS25244-PT15	700-092-15
MS Approved	20	0.25	MS25244-20	700-001-20	MS25244-P20	700-089-20	MS25244-PT20	700-092-20
MS Approved	25	0.25	MS25244-25	700-001-25	MS25244-P25	700-089-25	MS25244-PT25	700-092-25
MS Approved	30	0.25	MS25244-30	700-001-30	MS25244-P30	700-089-30	MS25244-PT30	700-092-30
MS Approved	35	0.25	MS25244-35	700-001-35	MS25244-P35	700-089-35	MS25244-PT35	700-092-35
Non MS Approved	40	0.25		700-001-40		700-089-40		700-092-40
Non MS Approved	50	0.25		700-001-50		700-089-50		700-092-50

\* AT RATED NOMINAL CURRENT  
 Three phase variants are available as a 930 Series.  
 For other amperage ratings and configurations, consult the Business Unit.

**DIMENSIONS**

**700-001  
(MS25244)**

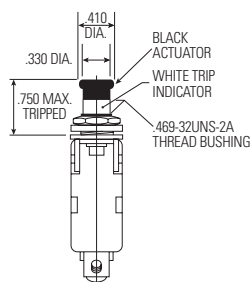
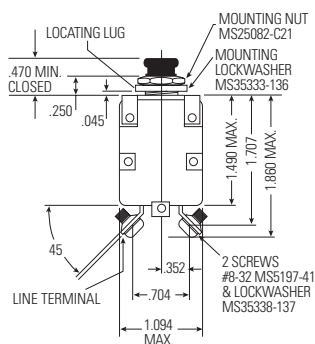
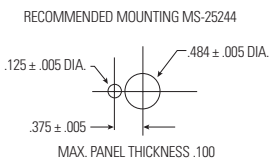
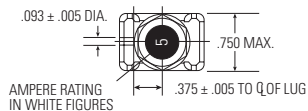

**700-089  
(MS25244-P)**

**700-092  
(MS25244-PT)**

Dimensions Different Base & Terminal

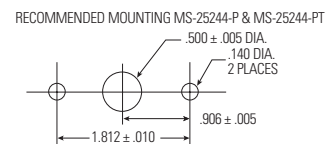
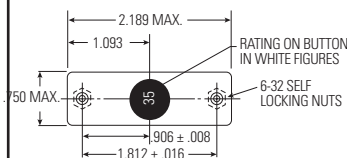

**MS25244-P Base & Terminal**

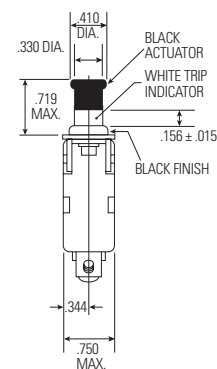
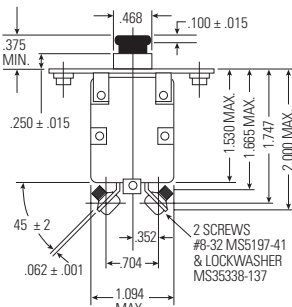

**MS25244-PT Base & Terminal**

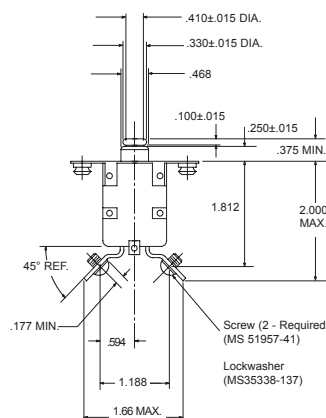

**TRIP CURVE**

