

General Specifications

- Designed to MIL-R-6106
 - Type II Unsealed Continuous Duty
 - Type III Unsealed Intermittent Duty
 - Covered/Gasketed Contact Area
 - Twin-break Silver Alloy Contacts
- Meets Explosion, Humidit, Salt, Spray, Sand, and Dust requirements.
- Altitude: 50,000 feet
- Shock: 25 g's ½ Sine 6 to 9 milliseconds
 - Maximum contact opening: 2 milliseconds
- Acceleration: 10 g's
- Vibration Limits:
 - 5 to 10 Hz: 0.8 in DA
 - 10 to 55 Hz: 0.6 in DA
 - 55 to 2000 Hz: 2 g's
- Temperature Range: -55°C to 71°C
- Insulation Resistance:
 - 100 megohm minimum initially
 - 50 megohm minimum after tests
- Dielectric:
 - 1250 Vac minimum initially
 - 1000 Vac minimum after tests
- Life:
 - Electrical Operations: 50,000 cycles
 - Mechanical Operations at 25% of Rated Resistive Load: 100,000 cycles
- Minimum Current: 10% of Rated DC Resistive Load
- Intermittent Duty Ratings:
 - % of Rated Resistive
 - Time On in Minutes
 - Cooling time is required between successive over load applications.

Intermittent Duty Ratings

Minutes			
15	5	1	Inrush
130%	150%	200%	600%
Rupture Time Per MIL-R-6106			

(Coil Voltage must be maintained at rated value)

- Options:
 - Other Coil Voltage
 - Alternate Mountings
- MIL-STD-461 applies to AC operated coils.
- See drawing for additional applicable details.

Special Service Use

Mechanical Interlock/Type Service

Part Number	Reversing	Transfer	Dynamic Braking
9565H29	X	X	—
6046H39	X	—	X
6046H46	X	X	—
6046H53	X	X	—



Cat N. 6041H217

- SPST rated 400 Amp resistive and motor at 28 Vdc continuous duty with top mounting.
- MS24185-D1 - 2.6 Lbs/ 1179gm



Cat N. 6041H202

- SPST rated 200 Amp resistive and motor at 28 Vdc continuous duty with side mounting.
- MS24171-D2 - 1.25 Lbs/ 567gm



Cat N. 6041H209

- 2 PST rated 100 Amp resistive at 28 Vdc and 75 amperes 115/200 V 400 Hz intermittent duty with top mounting.
- AN-3392-1 - 1.5 Lbs/ 680 gm



Cat N. 6041H201

- SPST rated 50 Amp resistive, inductive and motor at 28 Vdc continuous duty with side mounting.
- MS24166-D2 - 0.5 Lbs/ 225 gm



Cat N. 9565H2

- 3 PST rated 25 Amp resistive, inductive and motor at 28 Vdc and 115/200 V 400 Hz continuous duty cycle with base mounting.
- MS24192-D1 - 1.1 Lbs/ 499 gm

Reversing and Dynamic Braking Relay



Cat N. 6046H39

- Control of split field series motors.
- SPST see circuit diagram 6 for details.
- Rated 28 Vdc 50 Amp N.O., 25 Amp N.C
- 2.9 Lbs./1315 gm

POWER RELAYS — CONTINUOUS DUTY, TYPE II, UNSEALED INTERMITTENT DUTY, TYPE III, UNSEALED

Safran Electrical & Power Part Number	Government Part Number	Continuous Power Contacts, Ratings						Contacts Operate Milliseconds, Maximum				Coil Data							
		28VDC			115/200 VAC 400 Hz.			OP TIME	REL TIME	Contact Bounce	Poles & Throw ^③	Weight Lbs./GMS	Circuit Dia./ Dim. Figure	Resistance (OHMS)± 10% Pickup/ Sealed	Volts Pickup ^⑤	Volts Drop-out ^⑥	Duty Cycle	Mounting	Coil Voltage Nominal
		RES.	IND.	MOTOR	RES.	IND.	MOTOR												
9565H2	MS24192-D2	25	25	25	25	25	25	20	15	6	3PST	1.1/498	10 / 11	/ 60	18	1.5 to 7	CONT	BASE	28 dc
9565H29	MS24152-D1	25	25	25	25	25	25	20	15	6	3PDT	2/909.09	16 / 11	22 / 92	18	1.5 to 7	CONT	BASE	28 dc
9565H95	—	25	25	25	25	25	25	20	15	6	3PST	1.06/482.95	10 / 11	/ 1160	70	8 to 38	CONT	BASE	120 dc
6041H53 ^②	—	50/25	50/25	50/25	25/25	—	—	20	15	5 N.O./10 N.C.	SPDT	.54/245.45	4 / 2	16.9	8.2	0.8 to 4.8	CONT	TOP	12 dc
6041H220 ^②	MS24187-D1	50/25	50/25	50/25	25/25	—	—	20	15	5 N.O./10 N.C.	SPDT	.54/245.45	4 / 2	94.2	18	1.5 to 9	CONT	TOP	28 dc
6041H230	MS24187-D2	50/25	50/25	50/25	25/25	—	—	20	15	5 N.O./10 N.C.	SPDT	.54/245.45	4 / 2	94.2	18	1.5 to 9	CONT	TOP	29 dc
6046H39 ^②	—	50/25	50/25	50/25	—	—	—	—	—	—	SPDT	2.9/1318.18	6 / 7	26	18	7	—	TOP	28 dc
6041H201	MS24166-D2	50	50	50	—	—	—	20	10	5	SPST	.50/225	1 / 4	94.2	18	1.5 to 7	CONT	SIDE	28 dc
6041H149	—	50	50	50	—	—	—	20	15	5	SPST	.56/254.55	1 / 4	16.9	8.2	0.8 to 4.8	CONT	SIDE	12 dc
6041H200	MS24166-D1	50	50	50	—	—	—	20	10	5	SPST	.50/225	1 / 4	94.2	18	1.5 to 7	CONT	TOP	28 dc
9565H94	MS24193-D1	50	50	50	50	50	50	20	15	4	3PST	1.51/685	10 / 11	13.5 / 71.5	18	1.5 to 7	CONT	BASE	28 dc
6041H219	MS24178-D1	55	40	40	55	—	35	—	—	—	DPST	.75/340.91	2 / 2	66	18	1.5 to 7	Note ^④	TOP	28 dc
6041H80	—	100	80	80	—	—	—	—	—	—	SPST	1.4/636.36	1 / 3	66.3	18	1.5 to 7	CONT	SIDE	28 dc
6041H144	—	100	80	80	—	—	—	—	—	—	SPST	1.4/636.36	1 / 3	66.3	18	1.5 to 7	CONT	SIDE	28 dc
6041H111	—	100	80	80	—	—	—	—	—	—	SPST	1.4/636.36	1 / 1	66.3	18	1.5 to 7	CONT	TOP	28 dc
6041H209	AN3362-1	100	80	80	75	—	65	35	10	3.5	DPST	1.5/685	2 / 2	43	20	1.5 to 7	Note ^④	TOP	28 dc
6046H53	MS25031-D1B	100	80	80	75	—	65	—	—	—	DPDT	3.5/1590.91	9 / 7	43	18	1.5 to 7	CONT	TOP	28 dc
9565H13	—	100	75	75	100	—	75	22	15	4	3PST	2.5/1136.36	12 / 11	9 / 53	18	1.5 to 7	CONT	BASE	28 dc
6041H202	MS24171-D2	200	100	200	—	—	—	25	10	50	SPST	1.25/568.18	1 / 5	66	18	1.5 to 7	CONT	SIDE	28 dc
6041H105	—	200	100	200	—	—	—	—	—	—	SPST	1.25/868.18	1 / 5	10 (+15/-10)	9	3.5	CONT	SIDE	12 dc
6041H123	—	200	100	200	—	—	—	40	15	5	SPST	1.3/590.91	1 / 5	66	18	1.5 to 7	CONT	SIDE	28 dc
6041H203	MS24172-D2	200	100	200	—	—	—	25	18	5	SPST	1.23/560	1 / 5	10 (+15/-10)	7.5	0.5 to 3.0	INTER ^③	SIDE	28 dc
6041H212	—	200	100	200	—	—	—	40	15	5	SPST	1.3/590.91	1 / 5	66	18	1.5 to 7	CONT	SIDE	28 dc
6041H215	MS24171-D1	200	100	200	—	—	—	25	10	5	SPST	1.33/604.55	1 / 1	66	18	1.5 to 7	CONT	TOP	28 dc
6041H216	MS24172-D1	200	100	200	—	—	—	25	10	5	SPST	1.33/604.55	1 / 1	10(+15/-10)	7.5	0.5 to 3.0	INTER ^③	TOP	28 dc
6046H46	MS25032-D1	200	100	150	150	—	100	40	15	5	DPDT	5.5/2500.00	8 / 7	41	18	1.5 to 7	CONT	TOP	28 dc
6041H205	MS24185-D2	400	100	400	—	—	—	40	15	5	SPST	2.6/1181.82	1 / 5	60	18	1.5 to 7	CONT	SIDE	28 dc
6041H217	MS24185-D1	400	100	400	—	—	—	40	15	5	SPST	2.6/1181.82	1 / 1	60	18	1.5 to 7	CONT	TOP	28 dc
6041H218	MS24179-D1	400	100	400	—	—	—	20	15	5	SPST	2.6/1181.82	1 / 1	10	7	0.5 to 3.0	INTER ^③	TOP	28 dc
6041H206	MS24179-D2	400	100	400	—	—	—	20	15	5	SPST	2.6/1181.82	1 / 5	10	7	0.5 to 3.0	INTER ^③	SIDE	28 dc

- ① Coil will exceed 95° C temperature rise when left on continuously in 25° ambient, but will not be damaged. At maximum ambient temperature of 71°C, the duty cycle should be limited to 15 minutes "on" time per half hour to obtain maximum coil life.
- ② Continuous and intermittent duty ratings shown are for N.O. pole rated at 1/2 the listed continuous DC duty ratings. N.C. pole on 6041H53 and H220 limited to 15 g's shock.
- ③ Time on 1 1/2 minutes at 29 Vdc. Minimum time off is 3 minutes.
- ④ All continuous duty resistive and motor load ratings and all intermittent duty ratings for all 3 pole relays listed under 28 Vdc apply for 120 Vdc systems with all 3 poles of the relay connected in the series.
- ⑤ Pick-up voltage below values shown may cause relay to rapidly cycle on and off (chatter).
- ⑥ Relay must drop-out at voltage value or less and may drop-out at any voltage below the higher voltage noted.

MS Part Number Summary			
AN3362-1*	6041H209	MS24179-D1	6041H218
MS24152-D1*	9565H29*	MS24185-D2	6041H205
MS24166-D1	6041H200	MS24187-D1	6041H220
MS24166-D2	6041H201	MS24187-D2	6041H230
MS24171-D1	6041H215	MS24192-D1	9565H2
MS24171-D2	6041H202	MS24193-D1	9565H94
MS24172-D1	6041H216	MS25031-D1B	6046H53
MS24172-D2	6041H203	MS24185-D1	6041H217
MS24178-D1	6041H219	MS25032-1	6046H46

*Inactive for new design

Conversion Part Number		
AN Part Number	Use MS Part Number	Safran Electrical & Power Part Number
3343-1	—	9565H13
3350-1	MS24166-D2	6041H201
3362-1	—	6041H209
3370-1	MS24171-D2	6041H202
3371-1	MS24172-D2	6041H203
3380-1	MS24185-D2	6041H205
—	MS25030-D1B	6041H51
3381-2	MS24179-D1	6041H218

Approximate Dimensions and Weights

Catalog Number	Ampere Ratings	Figure Number	Dimensions in Inches							Dimensions in Millimeters			Dimensions in Millimeters					
			Wide A	High B	Deep C	Mounting		Hole F	Net Stud G Power	Coil	Weight Lbs.	Wide A	High B	Deep C	Mounting		Hole F	Weight Grams
						D	E								D	E		
6041H11	100	1	3.27	3.13	2.08	—	2.75	0.27	.250-28 UNF	.138-32 UNC	1.4	83.06	79.5	52.83	—	69.85	6.86	636.36
6041H53	50/25	2	2.63	3.14	2.062	—	2.2	0.214	.190-32 UNF-2A	.138-32 UNC-2A	0.54	66.8	79.076	52.37	—	55.88	5.44	245.45
6041H80	100	3	2.91	3	2.08	—	2.26	0.276	.250-32 UNC	.138-32 UNC-2A	1.4	73.91	76.2	52.83	—	57.4	7.01	636.36
6041H105	200	5	4.406	3.28	1.99	—	2.395	0.276	.375-24 UNF-2A	.138-32 UNC-2A	1.25	111.92	83.31	50.55	—	60.83	7.01	568.18
6041H123	200	6	4.5	3.575	2	—	2.395	0.276	.375-24 UNF-2A	.138-32 UNC-2A	1.3	112.01	90.81	50.8	—	62.83	7.01	590.91
6041H144	100	3	3.33	3	2	—	2.26	0.276	.250-28 UNF	.138-32 UNC	1.4	84.58	76.2	50.8	—	57.4	7.01	636.36
6041H149	50	4	2.75	2.5	2.125	—	1.875	0.229	.190-32 UNC-2A	.138-32 UNC-2A	0.562	69.85	63.5	53.98	—	47.63	5.82	255.68
6041H200	50	2	2.75	2.625	2.125	—	2.188	0.219	.191-32 UNC-2A	.138-32 UNC-2A	0.5	69.85	66.68	53.98	—	55.58	5.56	225
6041H201	50	4	2.75	2.5	2.125	—	1.875	0.229	.190-32 UNC-2A	.138-32 UNC-2A	0.5	69.85	63.5	53.98	—	47.63	5.82	225
6041H202	200	5	4.41	3.28	1.99	—	2.395	0.276	.375-24 UNF-2A	.138-32 UNC-2A	1.25	112.01	83.31	50.55	—	60.83	7.01	568.18
6041H203	200	5	4.5	3.313	2	—	2.395	0.276	.375-24 UNF-2A	.138-32 UNC-2A	1.23	114.3	84.15	50.8	—	60.83	7.01	560
6041H205	400	5	5.5	3.92	2.438	—	2.406	0.276	.500-20 UNF-2A	.138-32 UNC-2A	2.6	139.7	99.57	61.93	—	61.11	7.01	1181.82
6041H206	400	5	5.5	3.92	2.438	—	2.406	0.276	.500-20 UNF-2A	.138-32 UNC-2A	2.6	139.7	99.57	61.93	—	61.11	7.01	1181.82
6041H209	100	2	3.469	3.406	2.656	—	2.948	0.276	.250-28 UNF-2B	.138-32 UNC-2B	1.5	88.11	86.51	67.46	—	74.88	7.01	681.82
6041H212	200	5	4.48	3.313	2.466	—	3.717	0.27	.375-24 UNF-2A	.138-32 UNC-2A	1.3	113.79	84.15	62.64	—	94.41	6.86	590.91
6041H215	200	1	4.406	3.75	2	—	3.01	0.276	.375-24 UNF-2A	.138-32 UNC-2A	1.33	111.91	95.25	50.8	—	76.45	7.01	604.55
6041H216	200	1	4.406	3.75	2	—	3.01	0.276	.375-24 UNF-2A	.138-32 UNC-2A	1.33	111.91	95.25	50.8	—	76.45	7.01	604.55
6041H217	400	1	5.5	4.5	2	—	3.01	0.276	.500-20 UNF-2A	.138-32 UNC-2A	2.6	139.7	114.3	50.8	—	76.45	7.01	1181.82
6041H218	400	1	5.5	4.5	2	—	3.01	0.276	.500-20 UNF-2A	.138-32 UNC-2A	2.6	139.7	114.3	50.8	—	76.45	7.01	1181.82
6041H219	55	2	2.922	2.844	2.031	—	2.385	0.223	.190-32 UNC-2B	.138-32 UNC-2B	0.75	74.22	72.24	51.59	—	60.58	5.66	340.91
6041H220	50/25	2	2.812	3.13	2.062	1.395	2.2	0.214	.190-32 UNF-2A	.137-32 UNC-2A	0.54	71.42	79.5	52.37	35.43	55.88	5.44	245.45
6046H39	50/25	7	4.82	3.45	2.25	2.01	4.301	0.228	.190-32	.138-32 UNC	2.9	122.43	87.63	57.15	51.05	109.25	5.79	1318.18
6046H46	200	7	7.688	4.125	3.468	1.76	6.895	0.266	.375-24 UNF	.138-32 UNC	5.5	195.28	104.78	88.09	44.7	175.13	6.76	2500
6046H53	100	7	6.688	3.75	2.656	2.125	6.02	0.266	.250-28 UNF	.138-32 UNC	3.5	169.88	95.25	67.46	53.98	152.91	6.76	1590.91
9565H2	25	11	3.063	2.75	2.75	2.688	2.49	0.229	.190-32 UNF-2B	.138-32 UNC-2B	1.062	77.8	69.85	68.85	68.28	63.25	5.82	482.95
9565H13	100	11	3.812	3.546	3.28	2.468	3.102	0.225	.250-28 UNF-2B	.164-32 UNC-2B	2.5	96.82	90.07	83.31	62.69	78.79	5.72	1136.36
9565H29	25	12	4.75	2.75	4.125	2.75	4.187	0.218	.190-32 UNF-2B	.164-32 UNC-2B	2.25	120.65	69.85	104.78	69.85	106.35	5.54	1022.73
9565H94	50	11	3.625	3.188	3.312	2.135	2.322	0.219	.190-32 UNF-2B	.164-32 UNC-2B	1.5	92.08	80.98	84.12	64.23	58.98	5.56	681.82
9565H95	25	11	3.063	2.75	2.75	2.494	0.229	.190-32 UNF-2B	.164-32 UNC-2B	1.06	77.8	69.85	69.85	63.35	5.82	481.82		

Note: All coils and auxiliary terminals are 6-32, except for Catalog Number 9565 relays which have 8-32 coil terminals. Dimensions are approximate and should not be used for construction purposes.

Dimension Figures

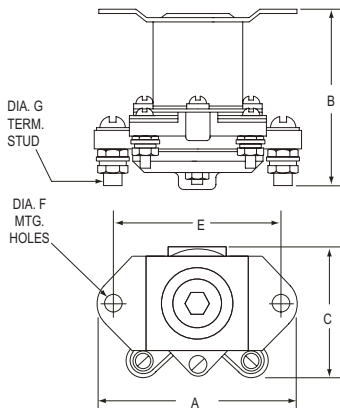

Figure 1

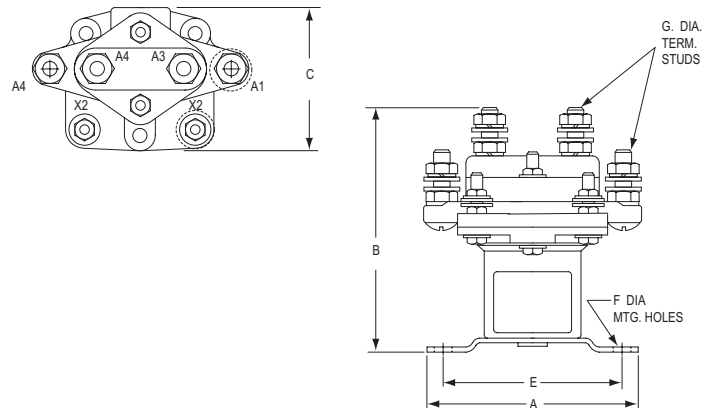

Figure 2

**POWER RELAYS — CONTINUOUS DUTY, TYPE II, UNSEALED
INTERMITTENT DUTY, TYPE III, UNSEALED**

Dimension Figures (cont.)

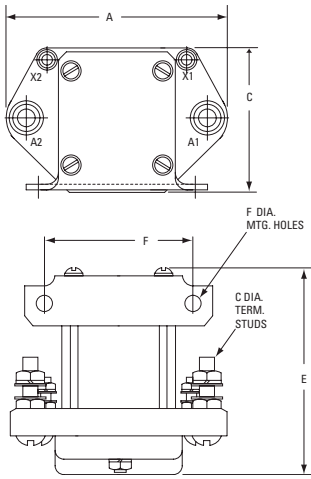

Figure 3

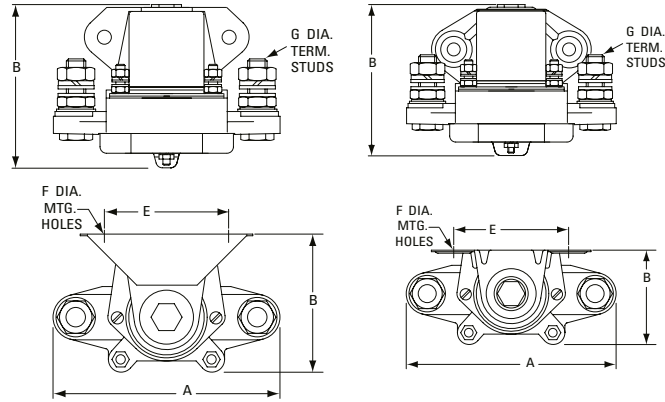

Figure 4

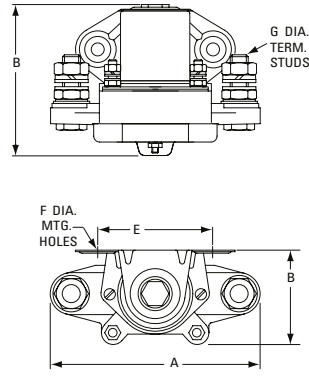

Figure 5

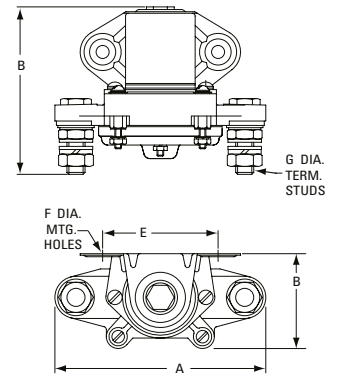

Figure 6

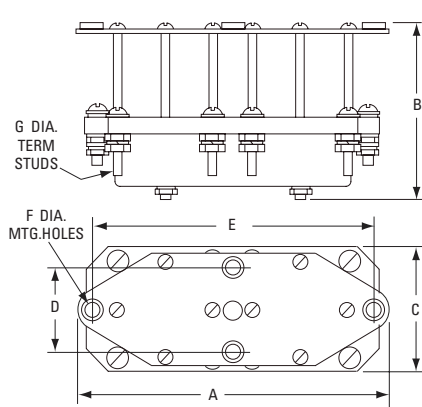

Figure 7

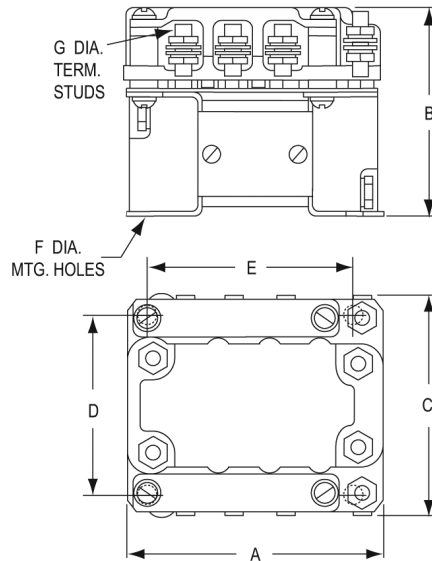

Figure 11

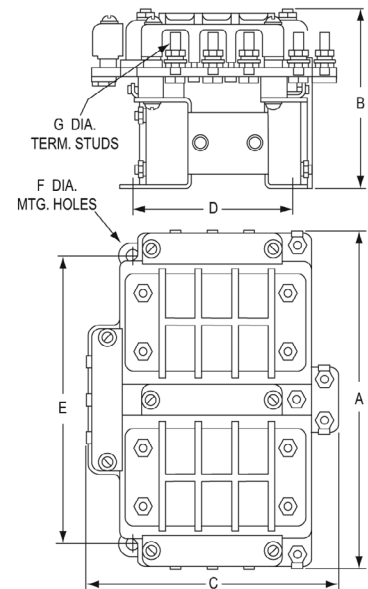

Figure 12

Typical Wiring Diagrams

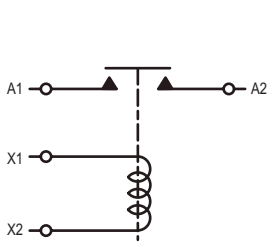

Diagram 1

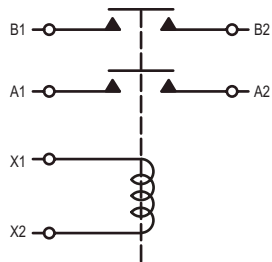

Diagram 2

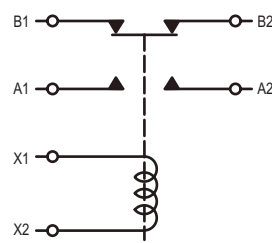

Diagram 3

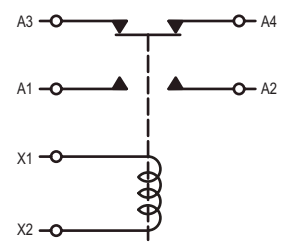

Diagram 4

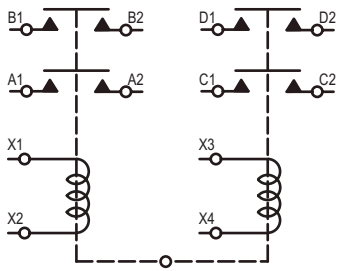

Diagram 8

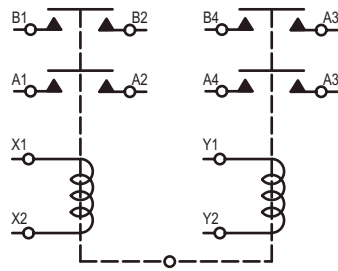

Diagram 9

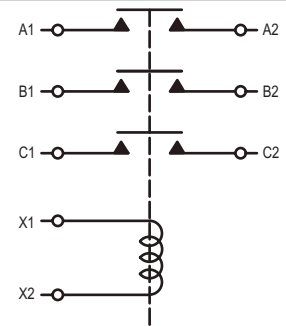

Diagram 10

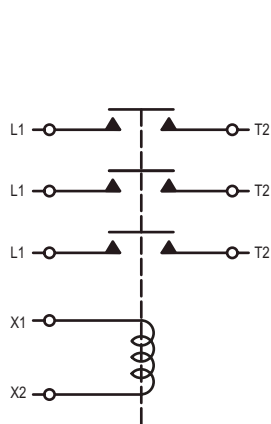

Diagram 12

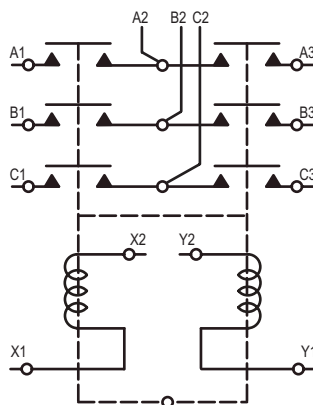

Diagram 16

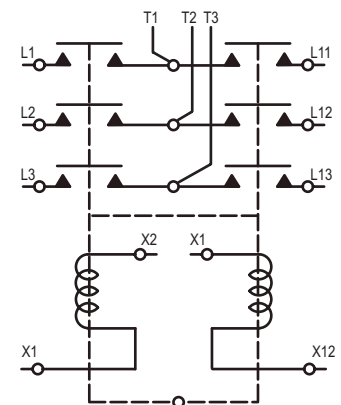

Diagram 18

POWER RELAYS — CONTINUOUS DUTY, TYPE II, UNSEALED INTERMITTENT DUTY, TYPE III, UNSEALED

P/N 6046H39

Typical Operation:

All items shown within dotted lines are part of the relay. All other parts external to dotted lines, including switches connected to C1 & C2 customer supplied.

Internal Mechanical Interlocks

Prevents the opposite contacts from transferring when either one of the coils is energized and the respective contacts are closed.

Reversing Operation

Closing either external start/stop switch at C1 or C2 will cause the motor to turn in either direction.

Dynamic Braking Operation

Internal switch provides for dynamic braking current flow through the motor shunt-fields series (SF) 1 and 2. Switch S is mechanically closed when either coil is energized and maintains that position until the alternate coil is energized. Switch S is shown in the last position commanded by external start/stop switch at C1.

